

An Indirect Model Predictive Current Control for a Direct Matrix Converter with Instantaneous Reactive Power Minimization

M. Rivera, S. Toledo
Faculty of Engineering
Universidad de Talca, Curicó, Chile
marcoriv@utalca.cl

P. Wheeler
Dep. of Electrical and Electronic Engineering
University of Nottingham, Nottingham, UK
pat.wheeler@nottingham.ac.uk

Abstract—Controlling both input and output sides of the direct matrix converter using predictive control implies high computational cost due to the fact that it has twenty-seven available switching states and the needed of weighting factors. In this paper, an indirect model predictive current control strategy is proposed in order to simplify the computational cost while avoiding the use of weighting factors. The method is based on the fictitious *dc*-link concept, which has been used in the past for the classical modulation and control techniques of the direct matrix converter. Simulated results confirm the feasibility of the proposal proving that it is an feasible alternative to classical predictive control strategies in this converter.

Index Terms—current control, matrix converters, predictive control, finite control set model predictive control, fictitious *dc*-link.

NOMENCLATURE

\mathbf{i}_s	Source current	$[i_{sA} \ i_{sB} \ i_{sC}]^T$
\mathbf{v}_s	Source voltage	$[v_{sA} \ v_{sB} \ v_{sC}]^T$
\mathbf{i}_i	Input current	$[i_A \ i_B \ i_C]^T$
\mathbf{v}_i	Input voltage	$[v_A \ v_B \ v_C]^T$
i_{dc}	Fictitious <i>dc</i> -link current	
v_{dc}	Fictitious <i>dc</i> -link voltage	
\mathbf{i}	Load current	$[i_a \ i_b \ i_c]^T$
\mathbf{v}	Load voltage	$[v_a \ v_b \ v_c]^T$
\mathbf{i}^*	Load current reference	$[i_a^* \ i_b^* \ i_c^*]^T$
C_f	Input filter capacitor	
L_f	Input filter inductor	
R_f	Input filter resistor	
R	Load resistance	
L	Load inductance	

I. INTRODUCTION

Owing to some advantages in terms of power densities and capability to operate in harsh pressures and temperatures [1], [2], in addition with some features as sinusoidal input and output currents as well as bidirectional power flow and adjustable input power factor [2], [3], the direct matrix converter (DMC) has been an important subject of research in the last decades.

Several modulation and control techniques have been applied to this converter being the most popular Venturini, Pulse Width Modulation (PWM), Space Vector Modulation (SVM) as well as Direct Torque Control (DTC) and Model Predictive Control (MPC) [3].

Thanks to the increments on calculation capability of nowadays digital signal processors, MPC has emerged as a real alternative for the control of power converters [4]. This technique determines the future behavior of a system based on its mathematical model and, using this predictions, selects the switching pattern to be applied in the next sampling time in order to achieve desired output signals. Some last contributions have been focused on PWM rectifiers [5], shunt active power filters [6], permanent magnet machines [7], matrix converters [8]–[12], among others.

The MPC strategy for DMC was fully implemented in a FPGA in [13], allowing control calculations fully paralleled, reducing complexity of hardware implementation. Besides, an hybrid combination between MPC and SVM is presented in [14] allowing the operation at fixed switching frequency but also the use of all the available switching states of the DMC (27), which is not possible in the traditional SVM technique where only the fixed vectors are considered. Despite the several progress of MPC for power converters, there are still some issues that are considered as an open topic for research. One of these issues is the correct selection of weighting factors when there are several control objectives, as instance current control and reactive power minimization in a power system. This issue is very relevant because it has a significant effect on the system performance. In most of the cases, this selection is done by using empirical process but there are some papers that offer some guidelines for the optimal weighting factor selection [15]–[19] but, most of them are complex solutions and require high computation cost. In order to solve the issues such as computational cost and weighting factor selections for the MPC in the DMC, in this paper an indirect model predictive current control strategy with reactive power minimization is proposed. The idea consists in to emulate the DMC as a two stage converter linked by a fictitious *dc*-link allowing a separated and parallel control of both input and output stages, avoiding the use of weighting factors.

II. MATHEMATICAL MODEL OF THE DMC

The mathematical model of the converter consist of the topology depicted in Fig. 1. This *ac/ac* power converter is formed by bidirectional switches which directly connect the

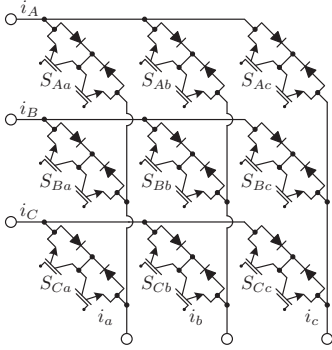

Fig. 1. Power circuit of the direct matrix converter.

input side with the load side without including any dc -link storage device. This converter has some operation constraints: due to the inductive nature of the load, the current cannot be interrupted abruptly, and the operation of the switches cannot short-circuit two input lines. These restrictions can be expressed by:

$$S_{Ay} + S_{By} + S_{Cy} = 1, \quad \forall y = a, b, c \quad (1)$$

The relations between the input and output variables of the DMC are defined by:

$$\mathbf{v}_o = \mathbf{T} \mathbf{v}_i \quad (2)$$

$$\mathbf{i}_i = \mathbf{T}^T \mathbf{i}_o \quad (3)$$

where \mathbf{T} is the instantaneous transfer matrix defined as:

$$\mathbf{T} = \begin{bmatrix} S_{Aa} & S_{Ba} & S_{Ca} \\ S_{Ab} & S_{Bb} & S_{Cb} \\ S_{Ac} & S_{Bc} & S_{Cc} \end{bmatrix} \quad (4)$$

An LC input filter has been included between the source and the bidirectional switches. This filter has mainly two purposes, in the one hand to prevent over-voltage due to fast commutation of currents \mathbf{i}_i , which produces short-circuiting the impedance of the power supply, and, in the other hand to eliminate high-frequency harmonics in the input currents \mathbf{i}_s .

Generally, all the control and modulation techniques are based on the equations (2) and (3). Basically, the most control techniques consist of determine the appropriate switches configuration to achieve the desired output voltage.

There are some techniques that uses the concept of fictitious dc -link in order to simplify the modulation and control of the DMC. This idea was proposed by Rodriguez in the 80's to modulate the DMC in a simple way [1], [20]. In fact, the concept of indirect matrix converter comes from this idea. The method consist in to divide the converter in a current source rectifier and a voltage source inverter linked by a fictitious dc -link such as represented in Fig. 2.

In this approach, there are six active current space vectors associated to the rectifier as is depicted in Fig. 3 (left) and in Table I. Moreover, the inverter have associated eight voltage space vectors which are represented in Fig. 3 (right) and

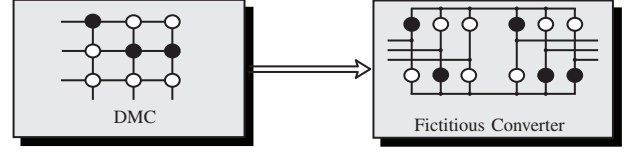

Fig. 2. Representation of the fictitious dc -link concept for the DMC.

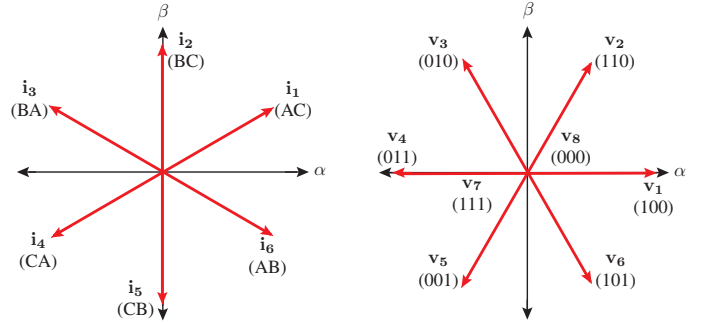

Fig. 3. Current and voltage space vector of the fictitious converter. Left: current space vectors for the fictitious rectifier, Right: voltage space vectors for the fictitious inverter.

TABLE I
VALID SWITCHING STATE ON THE FICTITIOUS RECTIFIER

#	S_{r1}	S_{r2}	S_{r3}	S_{r4}	S_{r5}	S_{r6}	i_A	i_B	i_C	v_{dc}
1	1	1	0	0	0	0	i_{dc}	0	$-i_{dc}$	v_{AC}
2	0	1	1	0	0	0	0	i_{dc}	$-i_{dc}$	v_{BC}
3	0	0	1	1	0	0	$-i_{dc}$	i_{dc}	0	$-v_{AB}$
4	0	0	0	1	1	0	$-i_{dc}$	0	i_{dc}	$-v_{AC}$
5	0	0	0	0	1	1	0	$-i_{dc}$	i_{dc}	$-v_{BC}$
6	1	0	0	0	0	1	i_{dc}	$-i_{dc}$	0	v_{AB}

TABLE II
VALID SWITCHING STATE ON THE FICTITIOUS INVERTER

#	S_{i1}	S_{i2}	S_{i3}	S_{i4}	S_{i5}	S_{i6}	v_{uv}	v_{vw}	v_{wu}	i_{dc}
1	1	1	0	0	0	1	v_{dc}	0	$-v_{dc}$	i_{ou}
2	1	1	1	0	0	0	0	v_{dc}	$-v_{dc}$	$i_{ou}+i_{ov}$
3	0	1	1	1	0	0	$-v_{dc}$	v_{dc}	0	i_{ov}
4	0	0	1	1	1	0	$-v_{dc}$	0	v_{dc}	$i_{ov}+i_{ow}$
5	0	0	0	1	1	1	0	$-v_{dc}$	v_{dc}	i_{ow}
6	1	0	0	0	1	1	v_{dc}	$-v_{dc}$	0	$i_{ou}+i_{ow}$
7	1	0	1	0	1	0	0	0	0	0
8	0	1	0	1	0	1	0	0	0	0

Table II. It is possible to control both converters separately, but considering the relationship between both stages. This situation allows that one stage of the converter can be controlled by one modulation or control technique and the other stage by another which could be different.

III. PROPOSED INDIRECT MODEL PREDICTIVE CONTROL METHOD FOR THE DMC

The general idea of the model predictive control for the DMC is represented in Fig. 4, where both input and output stages are controlled together by considering a predictive model of the instantaneous reactive input power and a predictive model of the load currents. These predictions are compared with their respective references in a single cost function (so it is necessary also to consider a weighting factor

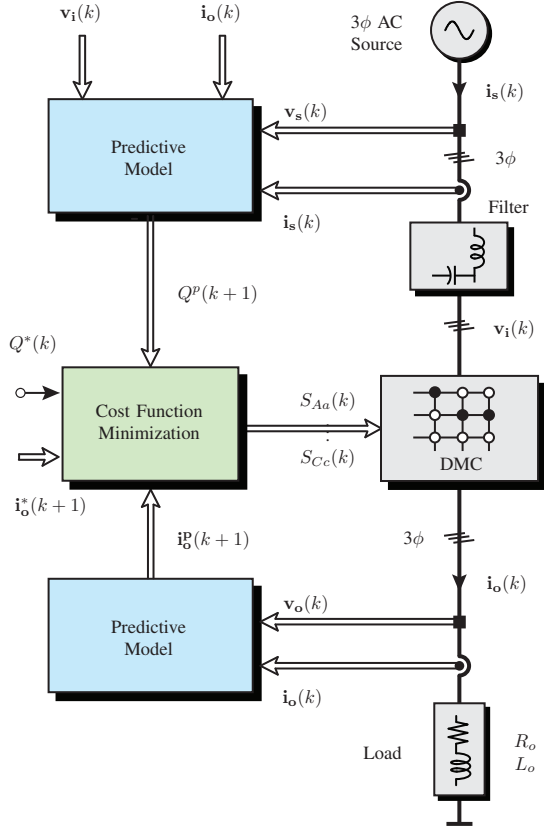

Fig. 4. Classic predictive current control strategy for the DMC.

in order to provide more priority to one of the controlled variables). The cost function is evaluated for each of the twenty-seven available switching states of the DMC and, the switching state that minimizes this cost function, is the one selected to be applied to the converter in the next sampling instant. In this method two main issues are observed: first, it is necessary the correct selection of a suitable weighting factor value in order to prioritise for the control of the load current or the instantaneous reactive input power and second, as the full converter control is considered, a large amount of available switching states is considered, requiring a fast microcontroller for such amount of calculations.

In order to solve these issues, in this paper the concept of fictitious dc -link is used to propose an indirect model predictive control for the DMC. The idea of this proposal is to separate the control of both input and output fictitious stages of the converter avoiding complex and large calculations and as well simplify the controller applying cost functions without weighting factors.

A. Control of the Rectifier

The rectifier stage has the input phase voltages \mathbf{v}_i and fictitious dc -link current i_{dc} as inputs and the fictitious dc -link voltage v_{dc} and input currents \mathbf{i}_i as outputs, this can be expressed as follows:

$$v_{dc} = \begin{bmatrix} S_{r1} - S_{r4} & S_{r3} - S_{r6} & S_{r5} - S_{r2} \end{bmatrix} \mathbf{v}_i \quad (5)$$

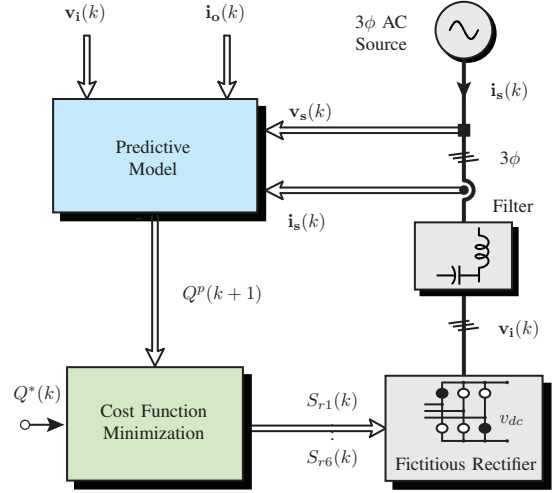

Fig. 5. Indirect predictive control strategy for the fictitious rectifier.

$$\mathbf{i}_i = \begin{bmatrix} S_{r1} - S_{r4} \\ S_{r3} - S_{r6} \\ S_{r5} - S_{r2} \end{bmatrix} i_{dc} \quad (6)$$

Equations (5) and (6) shows the relationship between the input and output signals in the rectifier side. As indicated in Fig. 3 (left) and Table I, there are six active current space vectors which correspond to the suitable switching states of the rectifier. The proposed technique detailed in Fig. 5, consists in to control the input side of the converter by considering these available switching states and considering the mathematical relationship between input and output voltages and currents.

In a similar way as the classical predictive strategy in the DMC, for the control of the input side it is necessary the prediction model of the source current which is given as follows:

$$\frac{d\mathbf{i}_s}{dt} = \frac{1}{L_f} (\mathbf{v}_s - \mathbf{v}_i) - \frac{R_f}{L_f} \mathbf{i}_s \quad (7)$$

$$\frac{dv_i}{dt} = \frac{1}{C_f} (\mathbf{i}_s - \mathbf{i}_i) \quad (8)$$

Since the predictive controller is formulated in discrete time, it is necessary to derive a discrete time model for the load-converter system. Based on the guidelines presented in [21] for the current and voltage predictions, it is possible to define the cost function g_r that minimizes the reactive power in the input in the α - β plane as follows:

$$g_r = [v_{s\alpha}(k+1)i_{s\beta}(k+1) - v_{s\beta}(k+1)i_{s\alpha}(k+1)]^2 \quad (9)$$

B. Control of the Inverter

Regarding the inverter side, the control diagram is represented in Fig. 6. In this case the inputs are the output currents \mathbf{i} and fictitious dc -link voltage v_{dc} . Meanwhile, the fictitious dc -link current i_{dc} and the output voltage \mathbf{v} are outputs. This can be seen in equations (10) and (11), respectively:

$$i_{dc} = \begin{bmatrix} S_{i1} & S_{i3} & S_{i5} \end{bmatrix} \mathbf{i} \quad (10)$$

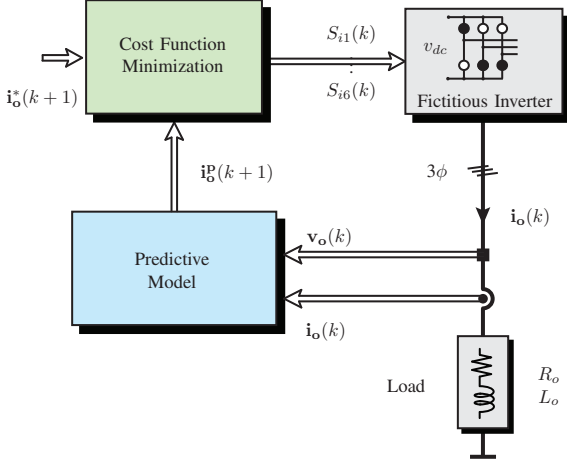

Fig. 6. Indirect predictive control strategy for the fictitious inverter.

$$\mathbf{v} = \begin{bmatrix} S_{i1} - S_{i4} \\ S_{i3} - S_{i6} \\ S_{i5} - S_{i2} \end{bmatrix} v_{dc} \quad (11)$$

Assuming a passive RL , the mathematical model is defined as:

$$\mathbf{v} = L \frac{d\mathbf{i}}{dt} + R\mathbf{i} \quad (12)$$

With these definitions, it is possible to obtain the prediction model of the output side using a forward Euler approximation in eq. (12), such as:

$$\mathbf{i}(k+1) = c_1 \mathbf{v}(k) + c_2 \mathbf{i}(k) \quad (13)$$

where, $c_1 = T_s/L$ and $c_2 = 1 - RT_s/L$, are constants dependent on load parameters and the sampling time T_s .

Lastly, the associated cost function g_i for current control in the output stage in α - β plane is defined as:

$$g_i = (i_{\alpha}^* - i_{\alpha}(k+1))^2 + (i_{\beta}^* - i_{\beta}(k+1))^2 \quad (14)$$

C. Relationship between the fictitious converter and the DMC

Finally, it is required to adapt the switching states of both input and output fictitious stages to the real one in order to apply the switching signals to the switches of the DMC. This is given by the relationship between input and output stages. As indicated in eq. (2), the relationship between the input voltage \mathbf{v}_i and load voltage \mathbf{v} depend on the state of the switching given by matrix \mathbf{T} . Based on the fictitious definition, the load voltage \mathbf{v} is given as indicated in eq. (11). At the same time, the fictitious dc -link voltage v_{dc} is given by eq. (5). In summary,

$$\mathbf{v} = \begin{bmatrix} S_{i1} - S_{i4} \\ S_{i3} - S_{i6} \\ S_{i5} - S_{i2} \end{bmatrix} \begin{bmatrix} S_{r1} - S_{r4} & S_{r3} - S_{r6} & S_{r5} - S_{r2} \end{bmatrix} \mathbf{v}_i \quad (15)$$

and thus the relationship between the switches of the DMC and fictitious converter is given as:

$$\begin{bmatrix} S_{Aa} \\ S_{Ba} \\ S_{Ca} \\ S_{Ab} \\ S_{Bb} \\ S_{Cb} \\ S_{Ac} \\ S_{Bc} \\ S_{Cc} \end{bmatrix} = \begin{bmatrix} (S_{i1} - S_{i4})(S_{r1} - S_{r4}) \\ (S_{i1} - S_{i4})(S_{r3} - S_{r6}) \\ (S_{i1} - S_{i4})(S_{r5} - S_{r2}) \\ (S_{i3} - S_{i6})(S_{r1} - S_{r4}) \\ (S_{i3} - S_{i6})(S_{r3} - S_{r6}) \\ (S_{i3} - S_{i6})(S_{r5} - S_{r2}) \\ (S_{i5} - S_{i2})(S_{r1} - S_{r4}) \\ (S_{i5} - S_{i2})(S_{r3} - S_{r6}) \\ (S_{i5} - S_{i2})(S_{r5} - S_{r2}) \end{bmatrix} \quad (16)$$

IV. RESULTS

In order to validate the effectiveness of the proposed method, simulation results in Matlab-Simulink were carried out in both steady and transient conditions. The simulation parameters are shown in Table III.

TABLE III
PARAMETERS OF THE IMPLEMENTATION

Variables	Description	Value
V_s	Amplitude ac -voltage	311[V]
C_f	Input filter capacitor	21[μ F]
L_f	Input filter inductor	400[μ H]
R_f	Input filter resistor	0.5[Ω]
R	Load resistance	10[Ω]
L	Load inductor	10[mH]
T_s	Sampling time	10 [μ s]
	Simulation step	1 [μ s]

A. Results in Steady State

Fig. 7 and Fig. 8 show simulations results in steady state for the proposed indirect predictive controller. In Fig. 7(a) is observed a source current i_{sA} in phase with to its respective source voltage v_{sA} with an almost sinusoidal waveform and a THD of 3.78%. The effect and performance of the input filter is also reflected in this figure where the high order harmonics present in Fig. 7(b) are eliminated as expected. In Fig. 7(b) it can be observed the commutated input current i_A , which is given as function of the DMC switches and the load currents \mathbf{i}_o . A very good tracking of the load currents \mathbf{i}_o to its respective references \mathbf{i}_o^* is observed in Fig. 8(a) with a sinusoidal waveform and a THD of 0.41%. In this case the reference is established as $I_o^*=12.5$ [A]. In Fig. 8(b) is also observed the load voltage which is given as a function of the DMC switches and the input voltages \mathbf{v}_i .

B. Results in Transient Condition

A step change in the load current is applied to the converter in order to evaluate the performance of the proposed strategy in terms of dynamic response. This analysis is done as depicted in Fig. 9 and Fig. 10. In Fig. 9 are shown the input variables where is observed a small resonance of the input filter due to the load variation, Fig. 9(a). It is important to highlight that this predictive control strategy shows a variable switching frequency. Despite of this resonance, it is also evident the good performance of the input filter which mitigates almost all the

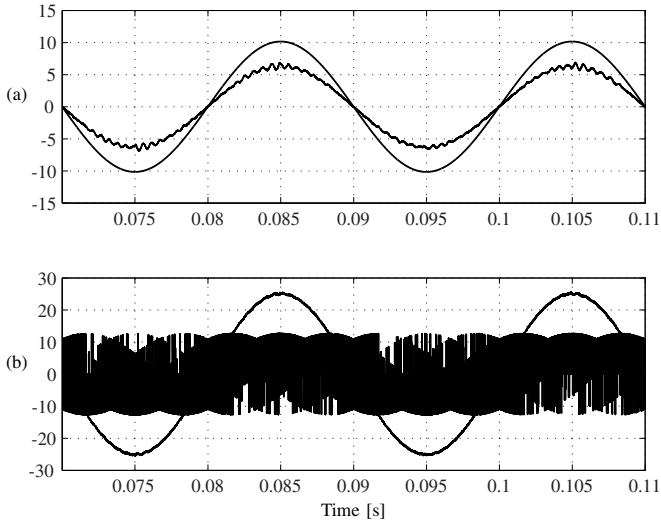

Fig. 7. Simulation results of the proposed method in steady state: (a) source voltage v_{sA} [V/25] and source current i_{sA} [A]; (b) capacitor voltage v_A [V/10] and input current i_A [A].

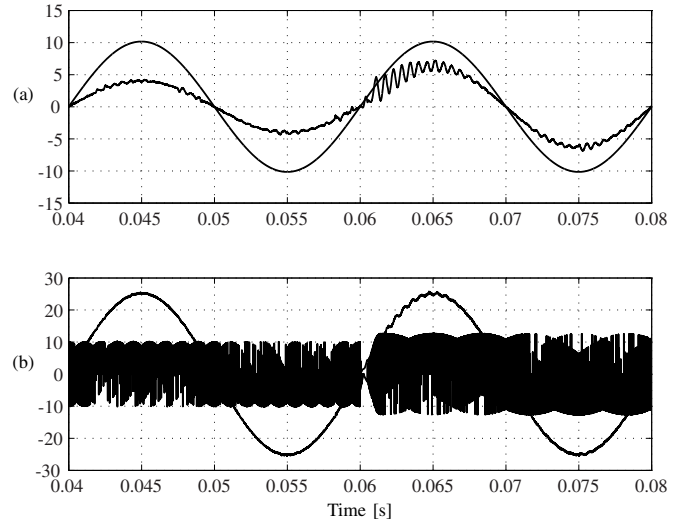

Fig. 9. Simulation results of the proposed method in transient state: (a) source voltage v_{sA} [V/25] and source current i_{sA} [A]; (b) capacitor voltage v_A [V/10] and input current i_A [A].

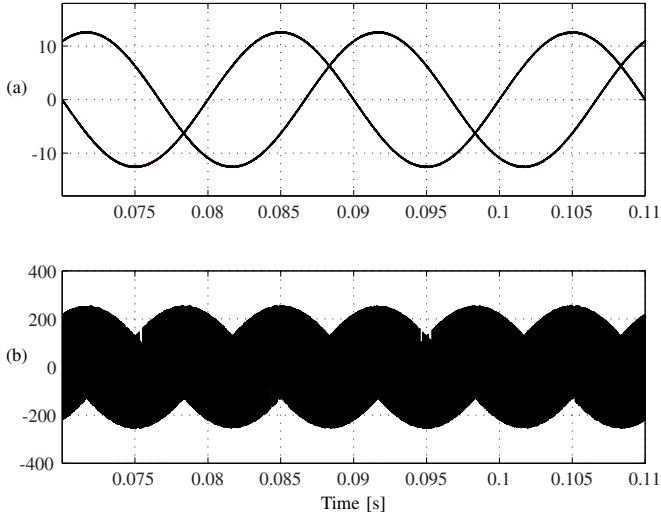

Fig. 8. Simulation results of the proposed method in steady state: (a) load currents i_o [A]; (b) load voltage v_a [V].

high harmonic frequencies observed in Fig. 9(b) which are produced by the commutation of the switches. In Fig. 10(a) is observed a good dynamic response of the load current i_o to its respective reference i_o^* with a very fast dynamic response and a very good tracking of the load current. The step change is from $I_o^*=10[A]$ @150Hz to $I_o^*=12.5[A]$ @50Hz. In both cases it is observed a very good tracking of the load current to its respective reference.

V. CONCLUSION

In this paper has been presented an indirect model predictive current control strategy with minimization of the instantaneous reactive input power for a direct matrix converter. The method uses the idea of fictitious dc -link in order to separate the control of both input and output stages of the converter. By

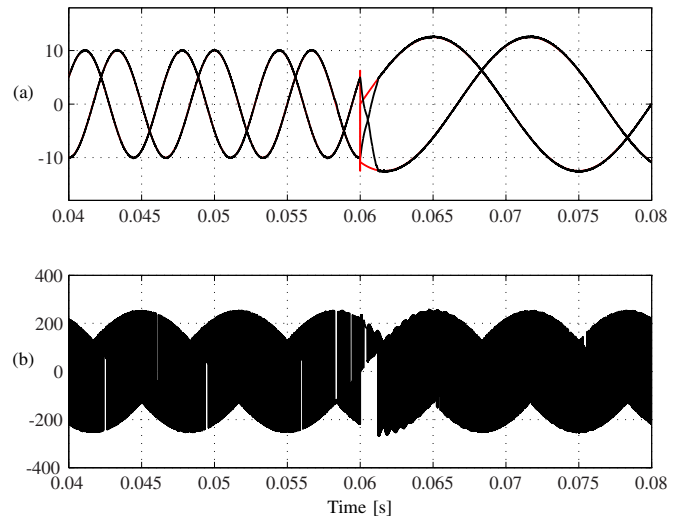

Fig. 10. Simulation results of the proposed method in transient state: (a) load currents i_o [A]; (b) load voltage v_a [V].

doing this, it is possible to reduce the complexity of the control but also avoid the calculation of a suitable weighting factor for the control of both instantaneous reactive input power and load currents variables.

By considering the proposed strategy, a new alternative has emerged for the control of both the input and load currents in a direct matrix converter.

ACKNOWLEDGMENTS

The authors would like to thank the financial support of Programa en Energías CONICYT - Ministerio de Energía ENER20160014, FONDECYT Regular 1160690 Research Project, 14-INV-097 CONACYT-FIUNA Project and Newton Picarte Project EPSRC: EP/N004043/1: New Configurations of

REFERENCES

- [1] P. Wheeler, J. Rodriguez, J. Clare, L. Empringham, and A. Weinstein, "Matrix converters: a technology review," *Industrial Electronics, IEEE Transactions on*, vol. 49, no. 2, pp. 276–288, Apr 2002.
- [2] L. Empringham, J. Kolar, J. Rodriguez, P. Wheeler, and J. Clare, "Technological issues and industrial application of matrix converters: A review," *Industrial Electronics, IEEE Transactions on*, vol. 60, no. 10, pp. 4260–4271, Oct 2013.
- [3] J. Rodriguez, M. Rivera, J. Kolar, and P. Wheeler, "A review of control and modulation methods for matrix converters," *Industrial Electronics, IEEE Transactions on*, vol. 59, no. 1, pp. 58–70, Jan 2012.
- [4] S. Vazquez, J. Rodriguez, M. Rivera, L. G. Franquelo, and M. Norambuena, "Model predictive control for power converters and drives: Advances and trends," *IEEE Transactions on Industrial Electronics*, vol. 64, no. 2, pp. 935–947, Feb 2017.
- [5] Y. Zhang, Y. Peng, and C. Qu, "Model predictive control and direct power control for pwm rectifiers with active power ripple minimization," *IEEE Transactions on Industry Applications*, vol. 52, no. 6, pp. 4909–4918, Nov 2016.
- [6] L. Tarisciotti, A. Formentini, A. Gaeta, M. Degano, P. Zanchetta, R. Rabbeni, and M. Pucci, "Model predictive control for shunt active filters with fixed switching frequency," *IEEE Transactions on Industry Applications*, vol. 53, no. 1, pp. 296–304, Jan 2017.
- [7] F. Mwasilu, H. Nguyen, H. H. Choi, and J. W. Jung, "Finite set model predictive control of interior pm synchronous motor drives with an external disturbance rejection technique," *IEEE/ASME Transactions on Mechatronics*, vol. PP, no. 99, pp. 1–1, 2016.
- [8] M. Rivera, P. Wheeler, A. Olloqui, and D. A. Khaburi, "A review of predictive control techniques for matrix converters - part i," in *2016 7th Power Electronics and Drive Systems Technologies Conference (PEDSTC)*, Feb 2016, pp. 582–588.
- [9] —, "A review of predictive control techniques for matrix converters - part ii," in *2016 7th Power Electronics and Drive Systems Technologies Conference (PEDSTC)*, Feb 2016, pp. 589–595.
- [10] S. Toledo, R. Gregor, M. Rivera, J. Rodas, D. Gregor, D. Caballero, F. Gavilán, and E. Maqueda, "Multi-modular matrix converter topology applied to distributed generation systems," in *8th IET International*
- [11] S. Toledo, M. Rivera, R. Gregor, J. Rodas, and L. Comparatore, "Predictive current control with reactive power minimization in six-phase wind energy generator using multi-modular direct matrix converter," in *2016 IEEE ANDESCON*, Oct 2016, pp. 1–4.
- [12] D. Caballero, F. Gavilan, E. Maqueda, R. Gregor, J. Rodas, , D. Gregor, S. Toledo, and M. Rivera, "Active and reactive power control strategy for grid-connected six-phase generator by using multi-modular matrix converters," *Journal of Systemics, Cybernetics and Informatics*, vol. 14, no. 6, pp. 57–61, 2016.
- [13] O. Gulbudak and E. Santi, "Fpga-based model predictive controller for direct matrix converter," *IEEE Transactions on Industrial Electronics*, vol. 63, no. 7, pp. 4560–4570, July 2016.
- [14] H. Huisman, M. Roes, and E. Lomonova, "Continuous control set space vector modulation for the 3x3 direct matrix converter," in *2016 18th European Conference on Power Electronics and Applications (EPE'16 ECCE Europe)*, Sept 2016, pp. 1–10.
- [15] S. A. Davari, D. A. Khaburi, and R. Kennel, "An improved fcs-mpc algorithm for an induction motor with an imposed optimized weighting factor," *IEEE Transactions on Power Electronics*, vol. 27, no. 3, pp. 1540–1551, March 2012.
- [16] C. A. Rojas, J. Rodriguez, F. Villarroel, J. R. Espinoza, C. A. Silva, and M. Trincado, "Predictive torque and flux control without weighting factors," *IEEE Transactions on Industrial Electronics*, vol. 60, no. 2, pp. 681–690, Feb 2013.
- [17] M. Uddin, S. Mekhilef, M. Rivera, and J. Rodriguez, "Predictive indirect matrix converter fed torque ripple minimization with weighting factor optimization," in *2014 International Power Electronics Conference (IPEC-Hiroshima 2014 - ECCE ASIA)*, May 2014, pp. 3574–3581.
- [18] Y. Zhang and H. Yang, "Two-vector-based model predictive torque control without weighting factors for induction motor drives," *IEEE Transactions on Power Electronics*, vol. 31, no. 2, pp. 1381–1390, Feb 2016.
- [19] V. P. Muddineni, A. K. Bonala, and S. R. Sandepudi, "Enhanced weighting factor selection for predictive torque control of induction motor drive based on vikor method," *IET Electric Power Applications*, vol. 10, no. 9, pp. 877–888, 2016.
- [20] J. Rodriguez, "A new control technique for ac-ac converters," *IFAC Control in Power Electronics and Electrical Drives, Lausanne Switzerland*, pp. 203–208, 1983.
- [21] C. F. Garcia, M. E. Rivera, J. R. Rodríguez, P. W. Wheeler, and R. S. Peña, "Predictive current control with instantaneous reactive power minimization for a four-leg indirect matrix converter," *IEEE Transactions on Industrial Electronics*, vol. 64, no. 2, pp. 922–929, Feb 2017.